

METTLER TOLEDO
Weighing terminal IND425

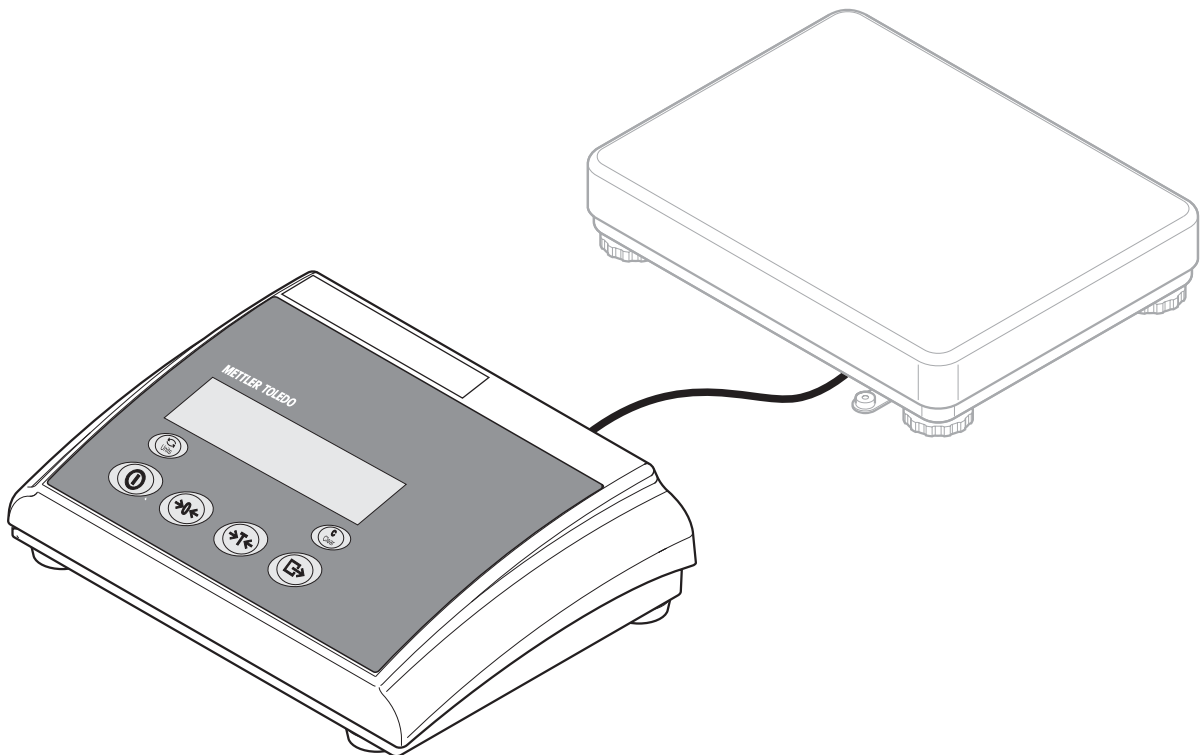



Congratulations on choosing the quality and precision of METTLER TOLEDO. Proper use according to this Operating Manual and regular calibration and maintenance by our factory-trained service team ensures dependable and accurate operation, protecting your investment. Contact us about a ServiceXXL agreement tailored to your needs and budget.

We invite you to register your product at www.mt.com/productregistration so we can contact you about enhancements, updates and important notifications concerning your product.

Table of contents

	Page
1	Introduction4
1.1	Safety instructions4
1.2	Description5
1.3	Putting into operation9
1.4	Disposal10
2	Operation11
2.1	Switching on and off11
2.2	Zeroing / Zero point correction11
2.3	Simple weighing11
2.4	Weighing with tare12
2.5	Dynamic weighing13
2.6	Printing results14
2.7	Cleaning14
3	Settings in the menu15
3.1	Operating the menu15
3.2	Overview17
3.3	Scale settings (SCALE)20
3.4	Application settings (APPLICATION)22
3.5	Terminal settings (TERMINAL)22
3.6	Configuring interfaces (COMMUNICATION)24
3.7	Diagnosis and printing out of the menu settings (DIAGNOS)27
4	Interface description28
4.1	SICS interface commands28
4.2	TOLEDO Continuous mode30
5	Event and error messages32
6	Technical data and accessories34
6.1	Technical data34
6.2	Accessories37
7	Appendix38
7.1	Safety checks38
7.2	Table of Geo Values38
8	Index41

1 Introduction

1.1 Safety instructions

**CAUTION!**

Do not use IND425 in hazardous areas!

Our product range includes special devices for hazardous areas.

**CAUTION!**

Terminals with protection level IP65 are dust-tight and hose-proof to EN 60529. They are suitable for use in dusty environment and brief contact with liquids. Ensure that the terminal is dried off again after coming into contact with liquid.

Even with degree of protection IP65 the terminal should not be used in environments in which there is a risk of corrosion.

- ▲ Do not flood the terminal or submerge it in liquid.

**DANGER!**

Electric shock hazard!

- ▲ Always pull out the mains plug before any work on the device.

**DANGER!**

Electric shock hazard if the mains cable is damaged!

- ▲ Check the mains cable for damage regularly and replace it immediately if it is damaged.
- ▲ On the rear side of the device, maintain a clearance of at least 3 cm in order to prevent the mains cable bending too much.

**CAUTION!**

On no account open the device!

The warranty is void if this stipulation is ignored. The device may only be opened by authorized persons.

- ▲ Call METTLER TOLEDO Service.

Note Use with foodstuffs

Parts coming into contact with foodstuffs have smooth surfaces and are easy to clean. The materials used do not splinter and are free of harmful substances.

With foodstuffs, it is recommended to use the supplied protective cover.

→ Clean the protective cover regularly and carefully.

→ Replace damaged or very dirty protective cover immediately.

1.2 Description

METTLER TOLEDO weighing platforms can be connected to the terminal IND425 without any problems.

The power supply is carried out via a built-in power supply device or an external battery.

One of the following options can also be ordered:

- Additional interface RS232 or RS485
- Ethernet interface
- USB interface
- Digital I/O
- OptionPac for AccuPac

1.2.1 Overview

- 1 Display
- 2 Specifications, rating plate
- 3 Keys

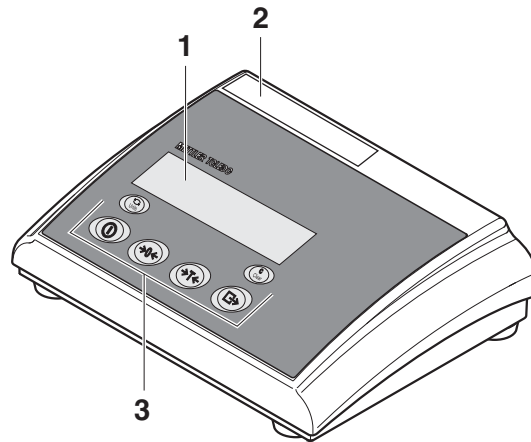

- 1 Power supply connection
- 2 Weighing platform connection
- 3 Optional interface
- 4 (Standard) RS interface

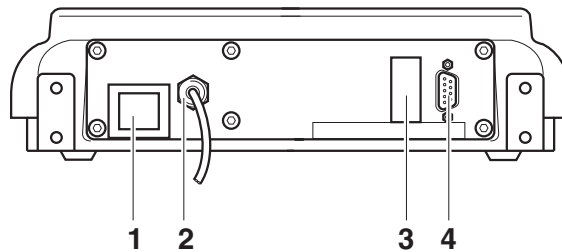



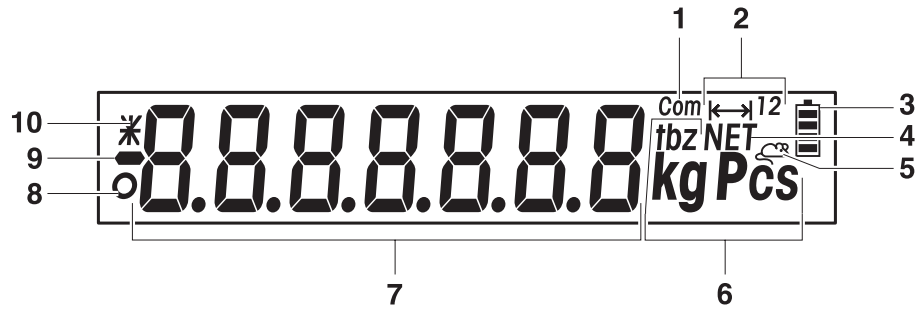

1.2.2 Display





- 1** Active interface
- 2** Weighing range display
- 3** Battery charge level; only present on scales with a battery
- 4** Symbol for displaying net values
- 5** Symbol for dynamic weighing
- 6** Weight units
- 7** 7-segment display, 7 digits, with decimal point
- 8** Stability monitor (goes out when a stable weight value is reached)
- 9** Sign
- 10** Identification for changed or calculated weight values, e.g. higher resolution, minimum weight not reached

1.2.3 Keypad

Main functions

Key	Function in operating mode	Function in the menu
	Switching device on / off, abort	To the last menu item –End–
	Setting scale to zero	Scrolling back
	Taring scale	Scrolling forward
	Transfer key Long key press: Calling up menu	Activating menu item Accepting selected setting

Additional functions

Key	Function
	Switching weight unit
	Clear key

1.3 Putting into operation

For startup, connect the terminal to an analog METTLER TOLEDO weighing platform (see installation instructions METTLER TOLEDO Terminals IND4.. or call METTLER TOLEDO Service).

1.3.1 Connecting the power supply



CAUTION!

Before connecting the scale to the mains, check whether the voltage value printed on the rating plate corresponds with the local mains voltage.

▲ Never connect the device if the voltage value printed on the rating plate is different to the local mains voltage.

→ Plug the mains plug into the socket.

After connection, the device performs a self-test. When the zero display appears, the device is ready to weigh.

→ Calibrate the device in order to obtain the greatest possible precision, see Section 3.3.1.

Note Partially certified scales (scales with first-level certification) must be certified by an authorized body or by the METTLER TOLEDO Service.

→ Call METTLER TOLEDO Service.

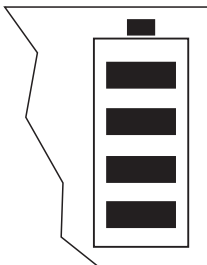

Terminals with AccuPac can work independently from the mains for approximately 30 hours in normal operation. A prerequisite for this is that the background lighting is switched off and that no peripheral devices are connected.

The battery symbol indicates the present charging level of the battery. 1 segment corresponds to approx. 25 % capacity. When the symbol flashes the battery must be charged (min. 4 hours). The charging period is extended if work is continued during charging. The battery is protected against overcharging.

The charging time of the storage battery amounts to approx. 6 hours. If the device continues to be operated during the charging process, the charging time is extended. The storage battery has a service life of approx. 1,000 charging/discharging cycles.

Note The storage battery is also suitable for permanent mains operation.

→ In order to obtain the full nominal capacity we recommend that you discharge the storage battery at regular intervals (approx. every 4 weeks) through normal operation.

1.4 Disposal

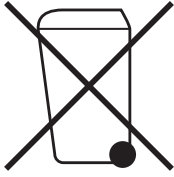

In conformance with the European Directive 2002/96 EC on Waste Electrical and Electronic Equipment (WEEE) this device may not be disposed of with domestic waste. This also applies to countries outside the EU, per their specific requirements.

→ Please dispose of this product in accordance with local regulations at the collecting point specified for electrical and electronic equipment.

If you have any questions, please contact the responsible authority or the distributor from which you purchased this device.

Should this device be passed on to other parties (for private or professional use), the content of this regulation must also be related.

Thank you for your contribution to environmental protection.

If the device is equipped with a storage battery:

The nickel metal hydride (NiMH) storage battery does not contain any heavy metals. However, it may not be disposed of with the normal refuse.

→ Observe the local regulations on the disposal of materials that are hazardous to the environment.

2 Operation

2.1 Switching on and off

Switching on → Press .

The scale conducts a display test. When the weight display appears, the scale is ready to weigh.

Switching off → Press .

Before the display goes out, -OFF- appears briefly.

2.2 Zeroing / Zero point correction

Zeroing corrects the influence of slight changes on the load plate.

- Manual**
1. Unload scale.
 2. Press .

The zero display appears.

Automatic In the case of scales that cannot be certified, the automatic zero point correction can be deactivated in the menu or the amount can be changed.

As standard, the zero point of the scale is automatically corrected when the scale is unloaded.

2.3 Simple weighing

1. Place weighing sample on scale.
2. Wait until the stability monitor  goes out.
3. Read weighing result.

2.4 Weighing with tare

2.4.1 Taring

→ Place the empty container on the scale and press .

The zero display and the symbol **NET** appear.

The tare weight remains saved until it is cleared.

2.4.2 Clearing the tare

→ Unload scale and press .

The symbol **NET** goes out, the zero display appears.

or

→ Press .

The symbol **NET** goes out, the gross weight appears in the display.

If **A.CL-tr** is activated in the menu, the tare weight is automatically cleared as soon as the scale is unloaded.

2.4.3 Automatic taring

Prerequisite

A-tArE is activated in the menu under **SCALE** → **tArE**, the symbol **T** flashes in the display.

The packaging material must be heavier than 9 display steps of the scale.

→ Place the container or packaging material on the scale.

The packaging weight is automatically saved as the tare weight, the zero display and the symbol **NET** appear.

2.4.4 Chain tare

Prerequisite

The tare function `CHAIIn.tr` is activated in the menu.

With this function it is possible to tare several times if, for example, cardboard is placed between individual layers in a container.

1. Place the first container or packaging material on the scale and press .

The packaging weight is automatically saved as the tare weight, the zero display and the symbol **NET** appear.
2. Weigh the weighing sample and read/print out the result.
3. Place the second container or packaging material on the scale and press  again.

The total weight on the scale is saved as the new tare weight. The zero display appears.
4. Weigh the weighing sample in the second container and read/print the result.
5. Repeat the last two steps for other containers.

2.5 Dynamic weighing

With the dynamic weighing function, it is possible to weigh restless weighing samples such as live animals. If this function is activated, the symbol  appears in the display.

With dynamic weighing, the scale calculates the mean value from 56 weighing operations within 4 seconds.

With manual start Prerequisite

`AVERAGE -> MANUAL` is selected in the menu.

The weighing sample must be heavier than 5 scale divisions.

1. Place the weighing sample on the scale and wait until it has stabilized.
2. Press  to start dynamic weighing.

During dynamic weighing, horizontal segments appear in the display, and the dynamic result is then displayed with the symbol *.
3. Unload the scale to be able to start a new dynamic weighing operation.

With automatic start Prerequisite

AVERAGE → AUTO is selected in the menu.

The weighing sample must be heavier than 5 scale divisions.

1. Place the weighing sample on the scale.

The scale starts the dynamic weighing automatically.

During dynamic weighing, horizontal segments appear in the display, and the dynamic result is then displayed with the symbol *.

2. Unload the scale to be able to perform a new dynamic weighing operation.

2.6 Printing results

If a printer or computer is connected to the scale, the weighing results can be printed out or sent to a computer.

→ Press .

The display contents are printed out and transferred to the computer.

2.7 Cleaning**CAUTION!**

Electric shock hazard!

- ▲ Before cleaning with a damp cloth, pull out the mains plug to disconnect the unit from the power supply.

Other cleaning information:

- Use damp cloths.
- Do not use any acids, alkalis or strong solvents.
- Do not clean using a high-pressure cleaning unit or under running water.
- Follow all the relevant instructions regarding cleaning intervals and permissible cleaning agents.

3 Settings in the menu

Settings can be changed and functions can be activated in the menu. This enables adaptation to individual weighing requirements.



The menu consists of 6 main blocks containing various submenus on several levels.

3.1 Operating the menu

3.1.1 Calling up the menu and entering the password



The menu differentiates between 2 operating levels: Operator and Supervisor. The Supervisor level can be protected by a password. When the device is delivered, both levels are accessible without a password.

Operator menu

1. Press  and keep it pressed until CODE appears.
2. Press  again.

The menu item tErMINL appears. Only the submenu dEVICE is accessible.

Supervisor menu

1. Press  and keep it pressed until CODE appears.
2. Enter the password and confirm with .



The first menu item SCALE appears.

Note

No supervisor password has been defined when the device is first delivered. Therefore respond to the password inquiry with  when you call up the menu for the first time. If a password has still not been entered after a few seconds, the scale returns to weighing mode.

Emergency password for Supervisor access to the menu

If a password has been issued for Supervisor access to the menu and you have forgotten it, you can still enter the menu:

- Press  3 times and confirm with .

3.1.2 Selecting and setting parameters

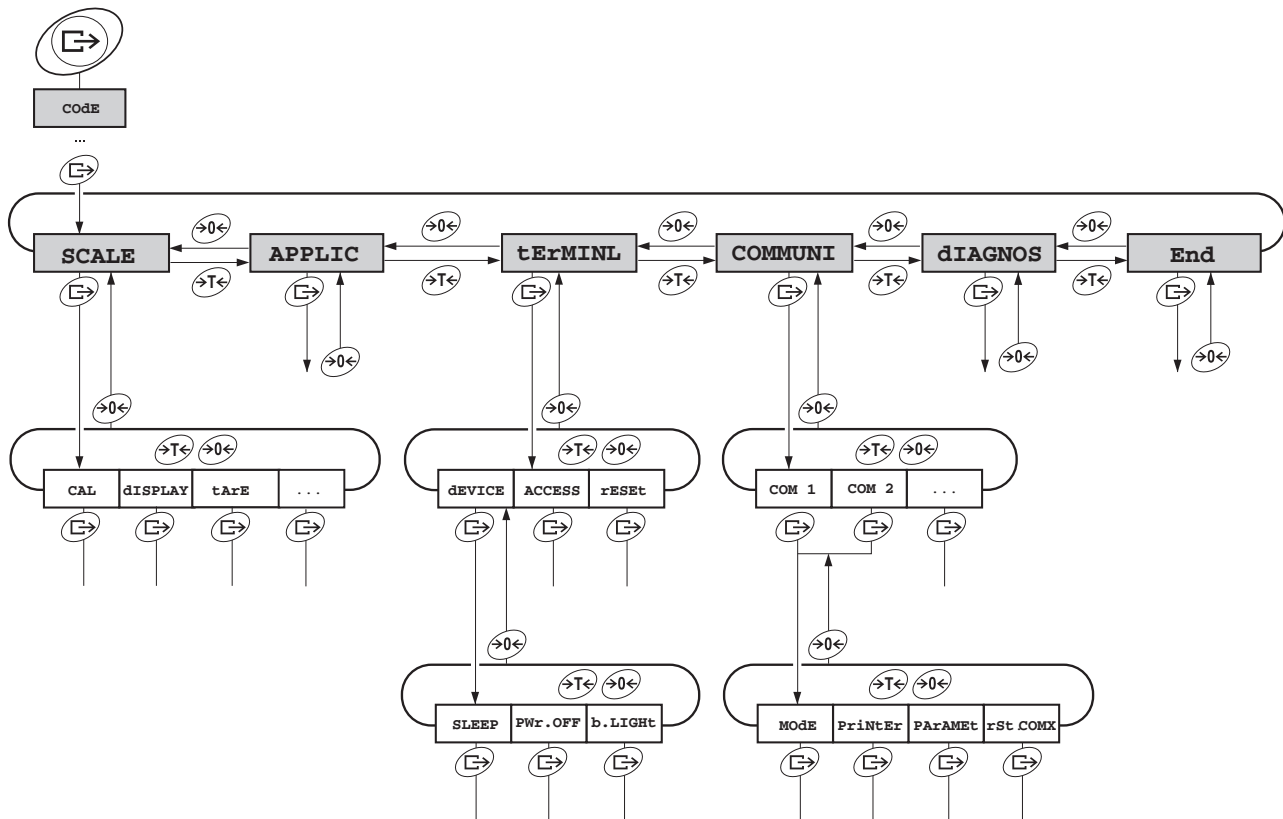

- Scrolling on one level**
- Scroll forward: Press $\rightarrow T \leftarrow$.
 - Scroll back: Press $\rightarrow 0 \leftarrow$.

- Activating menu items/
accepting selection**
- Press $\rightarrow \leftarrow$.

- Exiting menu**
1. Press $\textcircled{0}$.
The last menu item END appears.
 2. Press $\rightarrow \leftarrow$.
The inquiry SAVE appears.
 3. Confirm inquiry with $\rightarrow \leftarrow$ to save the settings and return to weighing mode.
-or-
→ Press $\rightarrow T \leftarrow$ to discard changes and return to weighing mode.

3.2 Overview

Level 1	Level 2	Level 3	Level 4	Level 5	Level 6	Page	
SCALE	CAL					20	
	dISPLAY	UNIt1	g, kg , oz, lb, t				20
		UNIt2	g , kg, oz, lb, t				
		rESOLU					
		UNt.rOLL	ON, OFF				
	tArE	A-tArE	ON, OFF				20
		ChAIn.tr	ON , OFF				
		A.CL-tr	ON, OFF , 9d				
	ZErO	AZM	OFF; 0.5 d; 1 d; 2 d; 5 d; 10 d				20
	rEStArt	ON/ OFF				21	
	FILtEr	VibrAt	LOW, MEd , HIGH,				21
		PrOCESs	UNIVER , dOSING				
		StAbILI	FASt, StAndrd , PrECISE				
Min.WEiG	ON/OFF	ON, OFF				21	
rESEt	SUrE?				21		
APPLIC	AVErAGE	OFF , AUtO, MAnuAL				22	
	rESEt	SUrE?				22	
tERMINL	dEVICE	SLEEP	OFF , 1 min, 3 min, 5 min, 15 min, 30 min			22	
		PWr OFF	OFF, 1 min, 3 min , 5 min, 15 min, 30 min				
		b.LIGHT	ON, OFF , 5 sec, 10 sec, 30 sec, 1 min				
	ACCESS	SUPeRVI				23	
	rESEt	SUrE?				23	



Level 1	Level 2	Level 3	Level 4	Level 5	Level 6	Page	
COMMUNI	COM 1/COM 2	MODE	Print			24	
			A.Print				
			CONTINU				
			dIALOG				
			CONT.OLd				
			dIAL.OLd				
			dt-b	GrOSS	ON, OFF		
				tArE	ON, OFF		
				nEt	ON, OFF		
			dt-G	GrOSS	ON, OFF		
				tArE	ON, OFF		
				nEt	ON, OFF		
			COnt-Wt				
		2nd.dISP					
		InSt.Prn					
		PrINtEr	Type	ASCII , LABEL			24
			tEmPLat	StdArd , tEMPLt1, tEMPLt2			
			ASCI.Fmt	LINE.FMt	MULTI SINGLE FIXEd		
				LENGtH	1 ... 100		
				SEPARAt	, ; ...		
				Add LF	0 ... 9		
			PARAMEt	bAUD	300 ... 38400		
		PARity		7 nonE, 8 nonE, 7 odd, 8 odd, 7 EVEN , 8 EVEN			
H.SHAKE	NO, XONXOFF , nEt 422, nEt 485						
NEt.Addr	0 ... 31						
ChECSuM	ON, OFF						
Vcc	ON, OFF						
rSt.COMx	SUrE?			25			

Level 1	Level 2	Level 3	Level 4	Level 5	Level 6	Page	
COMMUNI	OPTION	Eth.NET	IP.AddrS, SUBNET, GATEWAY			25	
		USb	USb tEST			25	
		diGital	IN 0 ... 3	OFF , ZER0, tArE, Print, CLEAR, Unit			25
			OUT 0 ... 3	OFF , StAbLE, bEL.Min, AbV.Min, UndErLd, OVErLd, StAr, ...			
			SEt.Pt 1				
		SEt.Pt 2					
dEF.PrN	tEmPLt1/ tEMPLt2	LINE 1 ... LINE 8	Not .USED , HEAdEr, GrOSS, tArE, nEt, StArLN, CrLF, F FEEd			26	
DIAGNOS	tEST SC	ExtErN				27	
	KboArđ						
	dISPLAY						
	SNr						
	LiSt						
	rESEt.AL	SUrE?					

3.3 Scale settings (SCALE)

3.3.1 CAL – calibration (adjustment)

This menu item is not available for certified scales without internal calibration weight.

CAL	<ol style="list-style-type: none"> 1. Unload scale. 2. Activate menu item CAL with . The scale determines the zero point. -0- appears in the display. The calibration weight to be placed on the scale then flashes in the display. 3. If necessary, change the weight value displayed with . 4. Place the calibration weight on the scale and confirm with . <p>The scale calibrates with the calibration weight loaded. After calibration is completed, -done- appears briefly in the display, and the scale automatically changes to the next point of the scale menu.</p>
-----	--

3.3.2 DISPLAY – weighing unit and display accuracy

UNIT1	Select weighing unit 1: g, kg, oz, lb, t
UNIT2	Select weighing unit 2: g, kg, oz, lb, t
RESOLU	Select readability (resolution), model-dependent
UNT.ROLL	When UNT.ROLL is switched on, the weight value can be displayed in all available units with  .
Notes	<ul style="list-style-type: none"> • In the case of certified scales individual sub-items of the DISPLAY menu item may not be available or only to a limited extent, depending on the respective country. • On dual-range/dual interval scales, resolutions marked with $\left \leftarrow \rightarrow \right 1/2$ are divided up into 2 weighing ranges/intervals, e.g. 2 x 3000 d.

3.3.3 TARE – tare function

A-tArE	Switching on/off automatic taring
CHAIIn.tr	Switching on/off chain tare
A.CL-tr	Switching on/off automatic clearing of the tare weight when the load is removed from scale Possible settings: OFF, ON, 9d

3.3.4 ZERO – automatic zero update

AZM	On certified scales, this menu item does not appear. Switching on/off automatic zero update and selecting zeroing range. Possible settings: OFF; 0.5 d; 1 d; 2 d; 5 d; 10 d
-----	---

3.3.5 RESTART – automatic saving of zero point and tare value

ON/OFF	When the Restart function is activated, the last zero point and tare value are saved. After switching off / on or after a power interruption, the device continues to work with the saved zero point and tare value.
---------------	--

3.3.6 FILTER – adaptation to the ambient conditions and the weighing type



VibrAt LOW MED HIGH	Adaptation to the ambient conditions <ul style="list-style-type: none"> • Very steady and stable environment. The scale works very quickly, but is very sensitive to external influences. • Normal environment. The scale operates at medium speed. • Restless environment. The scale works more slowly, but is insensitive to external influences.
PrOCeSS UNIVER dOSING	Adaptation to the weighing process <ul style="list-style-type: none"> • Universal setting for all weighing samples and normal weighing goods • Dispensing liquid or powdery weighing samples
StAbILI FASt StAndrd PrECISE	Adjusting the stability detection <ul style="list-style-type: none"> • The scale operates very fast. • The scale operates at medium speed. • The scale operates with the greatest possible reproducibility. <p>The slower the scale works, the greater the reproducibility of the weighing results.</p>

3.3.7 MIN.WEIG – minimum weight

This menu item appears only if the service technician has saved a minimum weight.

ON/OFF	Switching minimum weight function on/off If the weight on the scale falls below the stored minimum weight, an * appears on the display in front of the weight indicator.
---------------	---

3.3.8 RESET – resetting scale settings to factory settings



SUrE?	Confirmation inquiry <ul style="list-style-type: none"> • Reset the scale settings to factory settings with  • Do not reset scale settings with 
--------------	--

3.4 Application settings (APPLICATION)

3.4.1 AVERAGE – determining the average weight for an unstable load

OFF	Calculating average weight switched off
AUTO	Calculating average weight with automatic start of the weighing cycle
MANUAL	Calculating average weight with manual start of the weighing cycle via 

3.4.2 RESET – resetting application settings to factory settings





SURE?	Confirmation inquiry <ul style="list-style-type: none"> Reset the application settings to factory settings with  Do not reset the application settings with 
--------------	---

3.5 Terminal settings (TERMINAL)



3.5.1 DEVICE – Sleep mode, energy-saving mode and display backlighting

SLEEP	This menu item only appears on devices in mains operation. When SLEEP is activated, the scale switches off display and backlighting after the time period set when not in use. The display and backlighting are switched on again at the press of a key or if the weight changes. Possible settings: OFF, 1 min, 3 min, 5 min
PWR OFF OFF / 1 min / ...	This menu item only appears on devices in battery operation. When PWR OFF is activated, the device switches itself off automatically after approx. 3 minutes when not in use. Afterwards it has to be switched on using  . Possible settings: OFF (switched off), 1 min, 3 min, 5 min, 15 min, 30 min
b. LIGHT OFF / 5 sec / ...	Switching the display backlighting on/off. Setting whether and after which time the background lighting is to be switched off. Scales with a storage battery switch the background lighting off automatically by default when no action takes place at the scale for approx. 5 seconds. Possible settings: OFF (switched off), 5 sec, 10 sec, 30 sec, 1 min, ON (switched on)
Note	This menu item is accessible without a Supervisor password.

3.5.2 ACCESS – password for Supervisor menu access



<p>SUPeRVI</p> <p>ENtER.C</p> <p>rEtYPE.C</p>	<p>Password entry for Supervisor menu access</p> <p>Request to enter password</p> <p>→ Enter the password and confirm with </p> <p>Request to repeat the password entry</p> <p>→ Enter the password again and confirm with </p>
<p>Notes</p>	<ul style="list-style-type: none"> • The password can consist of up to 4 characters. • The key  must not be part of the password. It is required for confirming the password. • The key  may only be used in combination with another key. • If you enter an impermissible code or make a typing error in the repetition, COdE.Err. appears in the display.

3.5.3 RESET – resetting terminal settings to the factory settings

<p>SUre?</p>	<p>Confirmation inquiry</p> <ul style="list-style-type: none"> • Reset terminal settings to the factory settings with  • Do not reset the terminal settings with 
---------------------	---

3.6 Configuring interfaces (COMMUNICATION)

3.6.1 COM1/COM2 -> MODE – operating mode of the serial interface

Print	Manual data output to the printer with 
A.Print	Automatic output of stable results to the printer (e.g. for series weighing operations)
CONTINU	Ongoing output of all weight values via the interface
dIALOG	Bi-directional communication via MT-SICS commands, control of the scale via PC
CONT.OLD	As per CONTINU , see above, but with 2 fixed blanks in front of the unit (compatible with Spider 1/2/3)
dIAL.OLD	As per dIALOG , see above, but with 2 fixed blanks in front of the unit (compatible with Spider 1/2/3)
dt-b GROSS tArE nEt	DigiTOL-compatible format. <ul style="list-style-type: none"> • Transfer of the gross weight, identified with "B" • Transfer of the tare weight • Transfer of the net weight
dt-G	As per dt-b , see above, gross weight identified with "G"
Cont-Wt	TOLEDO Continuous mode
2nd.dISP	For connecting a second display (automatically activates the 5-V voltage supply at Pin 9)
InSt.Prn	Immediate manual data output to the printer with  (not certifiable)

3.6.2 COM1/COM2 -> PRINTER – settings for protocol printout



This menu item only appears if the mode "Print" or "A.Print" is selected.

tYPE ASCI I LabEL	Select the printer type <ul style="list-style-type: none"> • ASCII printer, e.g. Sprinter 1 • Label printer, capable of printing graphics
tEmPLat StdArd tEmPLt1 tEmPLt2	Selecting protocol printout <ul style="list-style-type: none"> • Standard printout • Printout in accordance with Template 1 • Printout in accordance with Template 2
ASCI.Fmt LINE.Fmt LENGtH SEPArAt Add LF	Selecting formats for the protocol printout <ul style="list-style-type: none"> • Line format: MULTI (multi-line), SINGLE (single-line) or FIXED • Line length: 0 ... 100 characters, appears only with line format MULTI or FIXED • Separator: , ; . / \ _ and space; appears only with line format SINGLE • Line feed: 0 ... 9

3.6.3 COM1/COM2 -> PARAMET – communication parameter







bAUd	Selecting baud rate: 300, 600, 1200, 2400, 4800, 9600, 19200, 38400 baud
PARity	Selecting parity: 7 none, 8 none, 7 odd, 8 odd, 7 even, 8 even
H.SHAKE	Select handshake: NO, XONXOFF, NET 422 (network operation via the optional RS422/RS485 interface via 4-wire bus, only for COM1), NET 485 (network operation via the optional RS422/RS485 interface via 2-wire bus, only for COM1)
NET.Addr	Assigning network address: 0 ... 31, only for NET 485
ChECsUM	Activating checksum byte (appears only in TOLEDO Continuous mode)
Vcc	Switching 5V voltage, e.g. for a bar code reader, on / off

3.6.4 COM1/COM2 -> RESET COM1/RESET COM2 – resetting serial interface to factory settings

SURe?	Confirmation inquiry <ul style="list-style-type: none"> Reset interface settings to factory settings with  Do not reset the interface settings with 
--------------	---

3.6.5 OPTION – configuring options

If no option is installed or is not yet configured, N.A. appears in the display.











EtH.NET IP.AddrS SUBNET GAtEWAY	Configuration of the Ethernet interface <ul style="list-style-type: none"> Enter IP address Enter Subnet address Enter Gateway address
USb USb TEST	Configuration of the USB interface <ul style="list-style-type: none"> Test of the USB interface. After the test has been passed, rEAdY appears in the display.
diGiTAL IN 0 ... 3 OFF ZErO tArE PriNt CLear UNIt	Configuration of the digital inputs/outputs Configuring inputs 0 ... 3 <ul style="list-style-type: none"> Input not assigned Key  Key  Key  Key  Key  Key 

OUT 0 ... 3	<ul style="list-style-type: none"> • Configuring outputs 0 ... 3
OFF	<ul style="list-style-type: none"> • Output not assigned
StAbLE	<ul style="list-style-type: none"> • Stable weight value
bEL.MIN	<ul style="list-style-type: none"> • Minimum weight not reached
AbV.MIN	<ul style="list-style-type: none"> • Minimum weight reached or exceeded
UNdErLd	<ul style="list-style-type: none"> • Insufficient load
OVERLd	<ul style="list-style-type: none"> • Overload
StAr	<ul style="list-style-type: none"> • Changed/calculated value
bEL.SP1	<ul style="list-style-type: none"> • Setpoint 1 not reached
AbV.SP1	<ul style="list-style-type: none"> • Setpoint 1 reached or exceeded
bEL.SP2	<ul style="list-style-type: none"> • Setpoint 2 not reached
AbV.SP2	<ul style="list-style-type: none"> • Setpoint 2 reached or exceeded
SEt.Pt1	Enter value for setpoint 1
SEt.Pt2	Enter value for setpoint 2

3.6.6 DEF.PRN – configuring templates

tEMPLt1/tEMPLt2	Selecting Template 1 or Template 2
LINE 1 ... 8	Select line
NOt.USEd	<ul style="list-style-type: none"> • Line not used
HEAdEr	<ul style="list-style-type: none"> • Line as header. The contents of the header must be defined via an interface command, see Section 4.1.
GROSS	<ul style="list-style-type: none"> • Gross weight
tArE	<ul style="list-style-type: none"> • Tare weight
nEt	<ul style="list-style-type: none"> • Net weight
StARLN	<ul style="list-style-type: none"> • Line with ***
CrLF	<ul style="list-style-type: none"> • Line feed (blank line)
F FEEd	<ul style="list-style-type: none"> • Page feed

3.7 Diagnosis and printing out of the menu settings (DIAGNOS)

<p>tEst SC External</p>	<p>Testing scale with external calibration weight</p> <ol style="list-style-type: none"> 1. The scale checks the zero point. -0- appears in the display. The test weight flashes in the display. 2. If necessary, change the weight value displayed with . 3. Put the calibration weight on the scale and confirm with . 4. The scale checks the calibration weight put on them. 5. After the test is completed, the deviation from the last calibration briefly appears in the display, ideally $\bar{d}=0.0g$, after which the scale changes to the next menu item KboArđ.
<p>KboArđ PUSH 1 . . . 6</p>	<p>Keyboard test</p> <ul style="list-style-type: none"> • Press the keys       in order. If the key works, the scale changes to the next key. <p>Note You cannot abort the keyboard test! If you have selected the menu item KboArđ, you must press all keys.</p>
<p>dISPLAY</p>	<p>Display test: The scale displays all functioning segments</p>
<p>SNr</p>	<p>Display of the serial number</p>
<p>LiSt</p>	<p>Printout of a list of all menu settings</p>
<p>rESet .AL SUrE?</p>	<p>Resetting all menu settings to the factory settings</p> <p>Confirmation inquiry</p> <ul style="list-style-type: none"> • Reset all menu settings to the factory settings with . • Do not reset the menu settings with .

4 Interface description

4.1 SICS interface commands

The terminal IND425 supports the command set MT-SICS (METTLER TOLEDO **Standard Interface Command Set**). With SICS commands, it is possible to configure, query and operate the terminal from a PC. SICS commands are divided up into various levels.

4.1.1 Available SICS commands

	Command	Meaning
LEVEL 0	@	Reset the scale
	I0	Inquiry of all available SICS commands
	I1	Inquiry of SICS level and SICS versions
	I2	Inquiry of scale data
	I3	Inquiry of scale software version
	I4	Inquiry of serial number
	I6	Inquiry of weighing parameters
	S	Send stable weight value
	SI	Send weight value immediately
	SIR	Send weight value repeatedly
	Z	Zero the scale
	ZI	Zero immediately
	LEVEL 1	D
DW		Weight display
K		Keyboard check
SR		Send and repeat stable weight value
T		Tare
TA		Tare value
TAC		Clear tare
TI		Tare immediately

In the case of Levels 0 and 1, these are commands which, if implemented, will function identically with all METTLER TOLEDO scales or weighing terminals.

In addition there are also further interface commands which apply either to the entire product series or to the particular application level. This and further information on the MT-SICS command set may be found in the MT-SICS Manual (Order Number 22 01 1 459 or at www.mt.com) or be obtained by request from your METTLER TOLEDO customer service representative.

4.1.2 Requirements for communication between scale and PC

- The scale must be connected to the RS232, RS485, USB or Ethernet interface of a PC with a suitable cable.
- The interface of the scale must be set to "Dialog" mode, see Section 3.6.1.
- A terminal program must be available on the PC, e.g. HyperTerminal.
- The communication parameters baud rate and parity must be set in the terminal program and on the scale to the same values, see Section 3.6.3.

4.1.3 Notes on network operation via the optional interface RS422/485

Up to 32 scales can be networked with the optional RS422/485 interface. In network operation, the scales must be addressed from the computer before commands can be sent and weighing results received.

Address	Hex	ASCII
0	0x30	0
1	0x31	1
2	0x32	2
...
9	0x39	9
10	0x3A	:
11	0x3B	;
...
31	0x4F	O

Description of the steps	Host	Direction	Scale
1. Host addresses the scale, e.g. with the address 3A hex.	<ESC> :	—>	
2. Host sends a SICS command, e.g. SI	SI <CRLF>	—>	
3. The scale confirms receipt of the command and sends the address back		<—	<ESC>:
4. The scale responds to the command and returns control of the bus to the host		<—	S_S___45.02_kg <CRLF>

4.2 TOLEDO Continuous mode

4.2.1 TOLEDO Continuous commands

In TOLEDO Continuous mode the scale supports the following input commands:

Command	Meaning
P	Printing out the current result
T	Taring of the scale
Z	Zero setting of the display
C	Deleting of the current value

4.2.2 Output format in TOLEDO Continuous mode

Weight values are always transferred in TOLEDO Continuous mode in the following format:

1	Status			Field 1						Field 2						17	18
	2	3	4	5	6	7	8	9	10	11	12	13	14	15	16		
STX	SWA	SWB	SWC	MSD	-	-	-	-	LSD	MSD	-	-	-	-	LSD	CR	CHK
Field 1		Cont-Wt: 6 digits for the weight value that is transferred without comma and unit															
Field 2		Cont-Wt: 6 digits for the tare weight that is transferred without comma and unit															
STX		ASCII character 02 hex, character for "start of text"															
SWA, SWB, SWC		Status words A, B, C, see below															
MSD		Most significant digit															
LSD		Least significant digit															
CR		Carriage Return, ASCII character 0D hex															
CHK		Checksum (2-complement of the binary sum of the 7 lower bits of all the characters sent beforehand incl. STX and CR)															

Status word A								
Function	Selection	Status bit						
		6	5	4	3	2	1	0
Decimal position	X00	0	1			0	0	0
	X0					0	0	1
	X					0	1	0
	0.X					0	1	1
	0.0X					1	0	0
	0.00X					1	0	1
	0.000X					1	1	0
	0.0000X					1	1	1
Numerical increment	X1			0	1			
	X2			1	0			
	X5			1	1			

Status word B	
Function/Value	Bit
Gross/Net: Net = 1	0
Sign: Negative = 1	1
Overload/Underload = 1	2
Movement = 1	3
lb/kg: kg = 1	4
1	5
Power up = 1	6

Status word C				
Function/Value				Bit
kg/lb	g	t	oz	
0	1	0	1	0
0	0	1	1	1
0	0	0	0	2
Print request = 1				3
Extended = 1				4
1				5
Tare manually, only kg = 1				6

5 Event and error messages

Error	Cause	Remedy
Display Dark	<ul style="list-style-type: none"> • Back lighting set too dark • No mains voltage • Unit switched off • Mains cable not plugged in • Brief fault 	<ul style="list-style-type: none"> → Set back lighting (b.LIGHT) brighter → Check mains → Switch on unit → Plug in mains plug → Switch device off and back on again
Insufficient load L _ _ _ _ J	<ul style="list-style-type: none"> • Load plate not on the scale • Weighing range not reached 	<ul style="list-style-type: none"> → Place load plate on the scale → Set to zero
Overload r - - - - 7	<ul style="list-style-type: none"> • Weighing range exceeded 	<ul style="list-style-type: none"> → Unload scale → Reduce preload
- - - - -	<ul style="list-style-type: none"> • Result not yet stable 	<ul style="list-style-type: none"> → If necessary adjust vibration adapter or weigh dynamically
- - n 0 - -	<ul style="list-style-type: none"> • Function not permissible 	<ul style="list-style-type: none"> → Unload scale and set to zero
r - n 0 - 7 L - n 0 - J	<ul style="list-style-type: none"> • Zeroing not possible with overload or insufficient load 	<ul style="list-style-type: none"> → Unload scale
Err 6	<ul style="list-style-type: none"> • No calibration 	<ul style="list-style-type: none"> → Unplug the mains plug then plug it back in; switch unit off and then back on in battery mode → Calibrate scale → Call METTLER TOLEDO Service
Err 17	<ul style="list-style-type: none"> • Printout not yet ended 	<ul style="list-style-type: none"> → End printout → Repeat required action
Err 18	<ul style="list-style-type: none"> • Switching the weighing unit impermissible during dynamic weighing 	<ul style="list-style-type: none"> → End dynamic weighing → Switch weighing unit
Err 53	<ul style="list-style-type: none"> • EAROM checksum error 	<ul style="list-style-type: none"> → Unplug the mains plug then plug it back in; switch unit off and then back on in battery mode → Call METTLER TOLEDO Service

Error	Cause	Remedy
Weight display unstable	<ul style="list-style-type: none"> • Restless installation location • Draft • Restless weighing sample • Contact between weighing pan and/or weighing sample and surroundings • Mains fault 	<ul style="list-style-type: none"> → Adjust vibration adapter → Avoid drafts → Dynamic weighing → Remedy contact → Check mains
Incorrect weight display	<ul style="list-style-type: none"> • Incorrect zeroing • Incorrect tare value • Contact between weighing pan and/or weighing sample and surroundings • Scale tilted 	<ul style="list-style-type: none"> → Unload scale, set to zero and repeat weighing operation → Clear tare → Remedy contact → Level scale

6 Technical data and accessories

6.1 Technical data

6.1.1 General data

IND425	
Applications	<ul style="list-style-type: none"> • Weighing • Dynamic weighing
Settings	<ul style="list-style-type: none"> • Resolution selectable • Weighing unit selectable: g, kg, oz, lb, t • Taring function: manual, automatic, chain tare • Automatic zero point correction when the scale is switched on and during operation • Filter for adapting to the ambient conditions (vibration adapter) • Filter for adapting to the weighing type, e.g. dispensing (weighing process adapter) • Switch-off function, sleep mode for mains-operated devices, energy-saving mode for battery operation • Display lighting
Display	<ul style="list-style-type: none"> • LCD (liquid crystal display), digits 16 mm high, with back lighting
Keypad	<ul style="list-style-type: none"> • Pressure point membrane keypad • Scratch-proof labeling
Housing	<ul style="list-style-type: none"> • Diecast aluminum housing • Dimensions, see Page 35
Protection Class (IEC 529, DIN 40050, EN60529)	<ul style="list-style-type: none"> • IP65 (not with Ethernet interface)
Mains connection	<p>Direct connection to the mains (MAINS supply voltage fluctuations up to $\pm 10\%$ of the nominal voltage):</p> <ul style="list-style-type: none"> • 230 V, 50 Hz, 70 mA • 240 V, 50 Hz, 70 mA • 120 V, 60 Hz, 90 mA • 100 V, 50/60 Hz, 90 mA <p>For battery operation:</p> <ul style="list-style-type: none"> • Connection via mains adapter: 90 – 264 V, 47 – 63 Hz, 300 mA • Infeed on the unit: 24 V, 1.3 A

IND425	
Battery operation	If the voltage supply is interrupted, the unit automatically switches over to battery operation
Ambient conditions	<ul style="list-style-type: none"> • Use Indoor use only • Altitude up to 2000 m • Temperature $-10 \dots +40 \text{ }^{\circ}\text{C} / 14 \dots 104 \text{ }^{\circ}\text{F}$ • Installation/overvoltage category II • Pollution degree 2 • Relative humidity Maximum relative humidity 80 % for temperatures up to $31 \text{ }^{\circ}\text{C} / 88 \text{ }^{\circ}\text{F}$, decreasing linearly to 50 % relative humidity at $40 \text{ }^{\circ}\text{C} / 104 \text{ }^{\circ}\text{F}$
Interfaces	<ul style="list-style-type: none"> • 1 RS232 interface integrated • 1 other optional interface possible

6.1.2 Dimensions

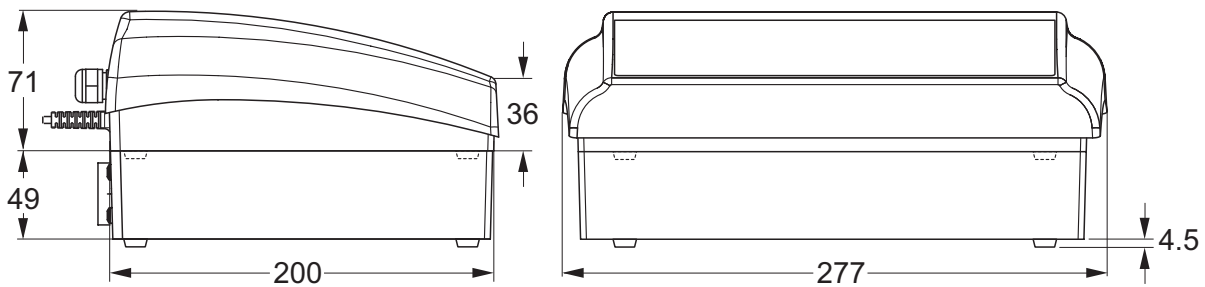

Dimensions in mm

6.1.3 Net weights

	without battery	with OptionPac (incl. battery)
IND4..	2.4 kg	4.4 kg

6.1.4 Interface connections

The compact scale can be fitted with a maximum of 2 interfaces. The following combinations are possible:

COM1	COM2	Note
RS232	–	
RS232	RS232	
RS485	RS232	COM1 can be optionally operated as RS422 or RS485
RS232	Ethernet	10BaseT, RJ45
RS232	USB	USB 1.1, Type B
RS232	Digital I/O	4 x in, 4 x out, D-Sub 9

6.1.5 Assignment of the interface connections

Pin	RS232 (COM1/COM2)	RS422 (4-wire, COM1)	RS485 (2-wire, COM1)	Digital I/O (COM2)
1	–	–	–	GND
2	TxD1/2	TxD1–	TxD1–/RxD1–	OUT0
3	RxD1/2	RxD1–	–	OUT1
4	–	–	–	OUT2
5	GND	GND	GND	OUT3
6	–	–	–	IN0
7	–	TxD1+	TxD1+/RxD1+	IN1
8	–	RxD1+	–	IN2
9	VCC	VCC	VCC	IN3

6.2 Accessories

Designation	Order number
Protective cover for IND4..	21 255 045
Wallmount for IND4..	22 011 471
Second display RS-PD/PASM	21 302 875
Second display ADI412	22 013 978
Second display ADI412-B, with backlighting	22 013 977
Relay box 4 for connection to digital I/O interface	22 011 967
Connection cable for relay box 4, length approx. 1.5 m	21 254 225
Printer Sprinter 1 Euro version	21 253 399
Printer Sprinter 1 UK version	21 253 745
RS232 cable for printer Sprinter 1, 1.8 m long	21 253 677
RS232 cable for PC, 1.8 m long	00 410 024

7 Appendix

7.1 Safety checks

The terminal IND425 has been tested by accredited inspection bodies. It has passed the safety checks listed below and carries the relevant test symbols. Production is subject to production monitoring by the inspection offices.

Country	Test symbol	Standard
Canada USA		CAN/CSA-C22.2 No. 1010.1-92 UL Std. No. 61010A-1
Other countries	CB Scheme (no identification)	IEC/EN61010-1:2001

7.2 Table of Geo Values

For weighing instruments verified at the manufacturer's, the geo value indicates the country or geographical zone for which the instrument is verified. The geo value set in the instrument (e.g. "Geo 18") appears briefly after switch-on or is specified on a label.

Table **GEO VALUES 3000e** shows the geo values for European countries.

Table **GEO VALUES 6000e/7500e** shows the geo values for different gravitation zones.

7.2.1 GEO VALUES 3000e, OIML Class III (European Countries)

Geographical latitude	Geo value	Country
46°22' – 49°01'	18	Austria
49°30' – 51°30'	21	Belgium
41°41' – 44°13'	16	Bulgaria
42°24' – 46°32'	18	Croatia
48°34' – 51°03'	20	Czechia
54°34' – 57°45'	23	Denmark
57°30' – 59°40'	24	Estonia
59°48' – 64°00'	25*	Finland
64°00' – 70°05'	26	
41°20' – 45°00'	17	France
45°00' – 51°00'	19*	
47°00' – 55°00'	20	Germany

Geographical latitude	Geo value	Country
34°48' – 41°45'	15	Greece
45°45' – 48°35'	19	Hungary
63°17' – 67°09'	26	Iceland
51°05' – 55°05'	22	Ireland
35°47' – 47°05'	17	Italy
55°30' – 58°04'	23	Latvia
47°03' – 47°14'	18	Liechtenstein
53°54' – 56°24'	22	Lithuania
49°27' – 50°11'	20	Luxemburg
50°46' – 53°32'	21	Netherlands
57°57' – 64°00'	24*	Norway
64°00' – 71°11'	26	
49°00' – 54°30'	21	Poland
36°58' – 42°10'	15	Portugal
43°37' – 48°15'	18	Romania
47°44' – 49°46'	19	Slovakia
45°26' – 46°35'	18	Slovenia
36°00' – 43°47'	15	Spain
55°20' – 62°00'	24*	Sweden
62°00' – 69°04'	26	
45°49' – 47°49'	18	Switzerland
35°51' – 42°06'	16	Turkey
49°00' – 55°00'	21*	United Kingdom
55°00' – 62°00'	23	

* factory setting

7.2.2 GEO VALUES 6000e/7500e OIML Class III (Height \leq 1000 m)

Geographical latitude	Geo value
00°00' – 12°44'	5
05°46' – 17°10'	6
12°44' – 20°45'	7
17°10' – 23°54'	8
20°45' – 26°45'	9
23°54' – 29°25'	10
26°45' – 31°56'	11
29°25' – 34°21'	12
31°56' – 36°41'	13
34°21' – 38°58'	14
36°41' – 41°12'	15
38°58' – 43°26'	16
41°12' – 45°38'	17
43°26' – 47°51'	18
45°38' – 50°06'	19
47°51' – 52°22'	20
50°06' – 54°41'	21
52°22' – 57°04'	22
54°41' – 59°32'	23
57°04' – 62°09'	24
59°32' – 64°55'	25
62°09' – 67°57'	26
64°55' – 71°21'	27
67°57' – 75°24'	28
71°21' – 80°56'	29
75°24' – 90°00'	30

8 Index

- A**
 Accessories 37
 Adjustment 20
 Ambient conditions 35
 Applications 34
 Average 13, 22
- C**
 Calibrate 20
 Chain tare 13
 Continuous mode 30
- D**
 Dimensions 35
 Display 7
 Display accuracy 20
 Dynamic weighing 13, 22
- E**
 Error messages 32
- F**
 Filter 21
- I**
 Interface protocol 30
 Interfaces
 Configure 24
 Connections 36
- K**
 Keyboard 8
- M**
 Mains connection 34
 Menu
 Application 22
 Communication 24
 Diagnosis 27
 Operation 15
 Overview 17
 Scale 20
 Terminal 22
 Menu structure 16
- O**
 Operator menu 15
 Options 5, 25
- P**
 Password 15
 Power supply 9
 Protocol 14
- R**
 Reset
 Application 22
 Interface 25
 Scale 21
 Terminal 23
 RS422/RS485 29
- S**
 Safety checks 38
 Settings 34
 SICS commands 28
 Supervisor menu 15
 Switching off 11
 Switching on 11
- T**
 Tare
 Automatic 12
 Chain tare 13
 Clear 12
 Terminal settings 22
 TOLEDO Continuous 30
- W**
 Weighing unit 20
 Weight 35
- Z**
 Zeroing 11

nefton
Ζύγιση
Σήμανση
Συμμόρφωση

Νεύτων Τεχνολογίες ΑΒΕΕ
Γέρακα 113, Τ.Θ. 67934
15344 Γέρακας
Τηλ: 210 6654544
Fax: 210 6654545
marketing@nefton.gr
www.nefton.gr



22011481B

Subject to technical changes © Mettler-Toledo (Albstadt) GmbH 05/08 Printed in Germany 22011481B

Mettler-Toledo (Albstadt) GmbH

D-72458 Albstadt

Tel. ++49-7431-14 0, Fax ++49-7431-14 232

Internet: <http://www.mt.com>